

FREE

Barbeque

2010 Buying Guide



LOWE'S

Home Improvement Warehouse™









gas barbeques

When it comes to gas barbeques, you'll find the hottest selection at Lowe's. Choose from brands including Weber®, Char-Broil® and Master Forge™, all at everyday low prices – guaranteed. So whether you're a beginner or a seasoned pro, grilling for dozens or grilling for one, Lowe's has the barbeque for you.



(Cover) Char-Broil
Two-Burner
Quantum Propane
Barbeque™
#298001.

Master Forge (Left),
Four-Burner
Propane Barbeque
#314073

	ITEM #	DESCRIPTION	TOTAL BTUs ¹	COOKING AREA ²	BURGER COUNT ³		COOKING SURFACE	NATURAL GAS	SIDE BURNER	ROTISSERIE BURNER	INFRARED BURNER	WARRANTY	PAGE #
	296475/ 188232	Weber Four-Burner Summit S-420™ Propane Barbeque	60,800	650	40		Stainless Steel	188232	✓			✓	9
	88326 / 137081	Weber Three-Burner Genesis® S-310™ Stainless Steel Propane Barbeque	42,000	637	35		Stainless Steel	137081				✓	10
	222412/ 51456	Weber Three-Burner Genesis® EP-310™ Black Propane Barbeque	42,000	637	35		Stainless Steel	51456				✓	10
	304839/ 121994	Weber Three-Burner Genesis® EP-310™ Espresso Propane Barbeque	42,000	637	35		Stainless Steel	121994				✓	11
	296457	Weber Spirit E-210™ Two-Burner Propane Barbeque	26,000	458	24		Porcelain-enameled Steel					✓	11
	154596	Char-Broil Four-Burner Quantum™ Propane Barbeque with Auto Clean	53,000	810	40		Quantum infrared	Conversion Kit: #92925	✓		✓	✓	12
	314410	Char-Broil Three-Burner Quantum™ Propane Barbeque	43,000	680	30		Quantum infrared	Conversion Kit: #92925	✓		✓	✓	13
	242266	Char-Broil Four-Burner Commercial Series Propane Barbeque	63,000	680	28		Porcelain Cast-Iron	Conversion Kit: #92925	✓			✓	14
	298001	Char-Broil Two-Burner Quantum Propane Barbeque™	21,000	465	25		Quantum infrared				✓	✓	13
	286052	Char-Broil Four-Burner Propane Barbeque	61,000	688	28		Cast-Iron		✓			✓	14
	80982	Char-Broil Two-Burner Propane Barbeque with Side Burner	45,000	515	28		Porcelain Coated Steel		✓			✓	15
	286515	Char-Broil Two-Burner Propane Barbeque	26,500	265	18		Porcelain Wire					✓	15
	296477	Nexgrill Five-Burner Propane & Charcoal Outdoor Kitchen	89,000	1,080	65		Stainless Steel & Cast-iron	Conversion Kit: #107694	✓	✓	✓	✓	16
	134489	Grill Master Four-Burner Propane Barbeque	60,000	667	35		Porcelain Coated Cast-iron		✓			✓	16

¹Total BTUs includes burners in firebox, side burners, and rotisserie burners (if equipped)

²Cooking area in square inches and based on main cooking grates and warming rack (if equipped)

³Burger count based on main cooking grates only



ITEM #	DESCRIPTION	PRIMARY BTUs*	COOKING AREA*	BURGER COUNT*		COOKING SURFACE	NATURAL GAS	SIDE BURNER	ROTISSERIE BURNER	INFRARED BURNER	WARRANTY	PAGE #
314075	Master Forge Five-Burner Propane Barbeque with Panini Press	91,250	787	45		Stainless Steel	Conversion Kit: #50772	✓	✓	✓	✓	17
67087	Master Forge Split Lid Propane Barbeque	73,750	893	50		Porcelain Cast-iron	Conversion Kit: # 81805	✓	✓	✓	✓	17
241317 / 241318	Master Forge Four-Burner Propane Barbeque	66,500	600	35		Stainless Steel	241318	✓			✓	18
314073	Master Forge Four-Burner Propane Barbeque	70,000	738	40		Porcelain Coated Stamped Steel	Conversion Kit: #50772	✓	✓	✓	✓	18
296449	Master Forge Four-Burner Propane Barbeque	58,000	674	35		Porcelain Cast-iron		✓			✓	19
196124	Master Forge Three-Burner Propane Barbeque	54,000	624	28		Porcelain Cast-iron		✓			✓	19

Buy a full tank or exchange an empty one



See cashier in-store for details

Prefer a natural gas barbeque?

Ask a sales associate about our natural gas barbeque options or which barbeques are convertible to natural gas with a do-it-yourself kit.



- Natural Gas Conversion Kit #92925**
- Natural Gas Conversion Kit #107694**
- Natural Gas Conversion Kit #50772**
- Natural Gas Conversion Kit #81805**

Glossary of Terms

BTU – British Thermal Units

The heat value of fuel – the higher the BTU, the more heat available for cooking.

Gas Cooking Systems

Conventional: A traditional gas burner usually covered with a metal V-shaped flame tamer. Cooks by circulating hot air around the food. Temperature range of 250 F to 650 F.

Infrared: System that produces heat, in which the heat penetrates the food and cooks without drying it out.

Cooking Grates

Chrome-Plated Steel Wire Rods: Resists rusting.

Porcelain-Coated Steel Wire Rods: Chip-resistant finish; rust resistant; resists food from sticking.

Cast-Iron: Even heat distribution; oiled (seasoned) grates resist food from sticking; high heat retention.

Porcelain-Coated Cast-Iron: Even heat distribution; resists rusting; resists food from sticking; high heat retention.

Stainless Steel: Rods or grates; resists rusting; high heat retention.

Auxiliary Burners

Side Burners: A circular burner usually built into the side shelf of a gas grill. (Sometimes designed with a high hood for use with a griddle.)

Ceramic /Sear Burners: High heat infrared burners used for searing; sears the outside of the meat to prevent juices from escaping. (Temperature range of 800 F to 1600 F.)

Rotisserie Burners: Burners set along the back of the firebox to prevent drippings from foods on a rotisserie from flaring up from the burners underneath. Can be conventional or ceramic.

Ignition types

Match / Lighter: Using a flame to manually start the fire.

Push & Turn: Pushing and turning the knob creates a manual spark.

Piezo: Electric starter that creates a single spark at the push of a button.

Electric: Creates a continuous stream of sparks as long as the ignition button is pressed. Battery operated.

Grill Material

Powder-Coated Steel: Dry powder coating process that creates a hard finish tougher than conventional paint; resists rusting; resists colour from fading.

Porcelain Steel: Powder glass fused to surface by firing at high temperature. Resists rusting, good heat retention, easy to clean, colour-fast.

Stainless Steel: A steel alloy blend of carbon steel and chromium to resist corrosion and staining.



Weber® full-size barbeques are designed for the long haul and built with the highest-grade materials to deliver Weber's proven performance, quality and durability.



Four-Burner Summit® S-420™ Propane Barbeque*

#296475/
188232

4 Burners | **60,800** Total BTU | **40** Burger Count

PERFORMANCE

Cooking area: 650 sq. in.
Cooking BTU-Main: 48,000
Cooking BTU-Side: 12,000

DURABILITY

Cooking surface:
Stainless steel
Ignition: Snap Jet™
Burner: Stainless Steel

ACCESSORIES

Covers: #297944
Rotisserie: #85787

PROPANE #296475

NATURAL GAS #188232

WARRANTIES Burner: 10 years | Parts: 2 years



**Three-Burner Genesis® S-310™
Stainless Steel Propane Barbeque**

#88326 /
137081

3 Burners | **42,000** Total BTU | **35** Burger Count

PERFORMANCE

Cooking area: 637 sq. in.
Cooking BTU-Main: 42,000

ACCESSORIES

Cover: #180176
Rotisserie: #51483

DURABILITY

Cooking surface:
Stainless steel
Ignition: Electronic
Burner: Stainless steel

PROPANE #88326

NATURAL GAS #137081

WARRANTIES

Burner: 10 year | Parts: 2 year



**Three-Burner Genesis® EP-310™
Espresso Propane Barbeque**

#304839 /
121994

3 Burners | **42,000** Total BTU | **35** Burger Count

PERFORMANCE

Cooking area: 637 sq. in.
Cooking BTU-Main: 42,000

ACCESSORIES

Covers: #180176
Rotisserie: #51483

DURABILITY

Cooking surface:
Stainless Steel
Ignition: Electronic
Burner: Stainless Steel

PROPANE #304839

NATURAL GAS #121994

WARRANTIES

Burner: 10 years | Parts: 2 years



**Three-Burner Genesis® EP-310™
Black Propane Barbeque**

#222412/
51456

3 Burners | **42,000** Total BTU | **35** Burger Count

PERFORMANCE

Cooking area: 637 sq. in.
Cooking BTU-Main: 42,000

ACCESSORIES

Covers: #180176
Rotisserie: #51483

DURABILITY

Cooking surface:
Stainless Steel
Ignition: Electronic
Burner: Stainless Steel

PROPANE #222412

NATURAL GAS #51456

WARRANTIES

Burner: 10 years | Parts: 2 years



**Two-Burner Spirit® E-210™
Propane Barbeque**

#296457

2 Burners | **26,000** Total BTU | **24** Burger Count

PERFORMANCE

Cooking area: 458 sq. in.
Cooking BTU-Main: 26,000

ACCESSORIES

Covers: #7047
Rotisserie: #51483

DURABILITY

Cooking surface:
Porcelain-enameled steel
Ignition: Electronic
Burner: Stainless Steel

WARRANTIES

Burner: 10 years | Parts: 2 years

COMMERCIAL
SERIES
Char-Broil

For more than 50 years, Char-Broil has been at the centre of outdoor entertaining. You'll find advanced cooking technology, precision grilling and affordable innovation offered in the Char-Broil Commercial Series, available exclusively at Lowe's everyday low prices.

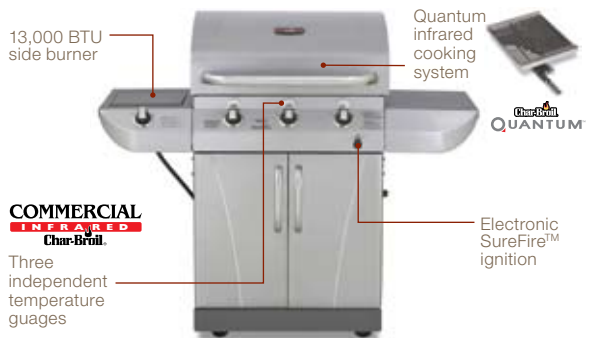

COMMERCIAL
INFRARED
Char-Broil

Three independent temperature gauges

Char-Broil
QUANTUM

Electronic SureFire™ ignition

Three-Burner Quantum™ Propane Barbeque

#314410

3 Burners | **43,000** Total BTU | **30** Burger Count

PERFORMANCE

Cooking area: 680 sq. in.
Cooking BTU-Main: 30,000
Cooking BTU-Side: 13,000

DURABILITY

Cooking surface: Quantum infrared
Ignition: Electronic SureFire™
Burner: Stainless steel

ACCESSORIES

Covers: #297963, 297938, 66444
Rotisseries: #101484, 297956
Natural Gas Conversion Kit: #92925

WARRANTIES Burner: Lifetime | Parts: 1 year

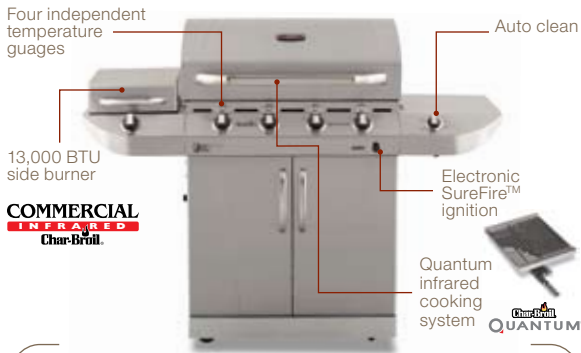

COMMERCIAL
INFRARED
Char-Broil

Quantum infrared cooking system

Four-Burner Quantum™ Propane Barbeque with Auto Clean

#154596

4 Burners | **53,000** Total BTU | **40** Burger Count

PERFORMANCE

Cooking area: 810 sq. in.
Cooking BTU-Main: 40,000
Cooking BTU-Side: 13,000

DURABILITY

Cooking surface: Quantum infrared
Ignition: Electronic Surefire™
Burner: Stainless steel

ACCESSORIES

Covers: #297963, 55257, 66444
Rotisseries: #101484, 297956
Natural Gas Conversion Kit: #92925

WARRANTIES Burner: Lifetime | Parts: 1 year



COMMERCIAL
INFRARED
Char-Broil

Electronic SureFire™ ignition

Quantum infrared cooking system

Two-Burner Quantum™ Propane Barbeque

#298001

2 Burners | **21,000** Total BTU | **25** Burger Count

PERFORMANCE

Cooking area: 465 sq. in.
Cooking BTU-Main: 21,000

DURABILITY

Cooking surface: Quantum infrared
Ignition: Electronic Surefire™
Burner: Stainless steel

ACCESSORIES

Cover: Included
Rotisseries: #101484, 297956

WARRANTIES Burner: Lifetime | Parts: 1 year



COMMERCIAL
S E R I E S
Char-Broil

Convertible to natural gas with kit #92925

Four-Burner Commercial Series Propane Barbeque

#242266

4 Burners | **63,000** Total BTU | **28** Burger Count

PERFORMANCE

Cooking area: 680 sq. in.
Cooking BTU-Main: 50,000
Cooking BTU-Side: 13,000

ACCESSORIES

Covers: #297936, 297938, 66444
Rotisseries: #101484, 297956
Natural Gas Conversion Kit: #92925

DURABILITY

Cooking surface: Porcelain cast-iron
Ignition: Electronic SureFire™
Burner: Stainless steel

WARRANTIES Burner: Lifetime | Parts: 1 year



Char-Broil

Two-Burner Propane Barbeque with Side Burner

#80982

2 Burners | **45,000** Total BTU | **28** Burger Count

PERFORMANCE

Cooking area: 515 sq. in.
Cooking BTU-Main: 35,000
Cooking BTU-Side: 10,000

ACCESSORIES

Covers: #55524, 187621, 297938

DURABILITY

Cooking surface: Porcelain coated steel
Ignition: Push button
Burner: Stainless steel

WARRANTIES Burner: 1 year | Parts: 1 year



Char-Broil

Four-Burner Propane Barbeque

#286052

4 Burners | **61,000** Total BTU | **28** Burger Count

PERFORMANCE

Cooking area: 688 sq. in.
Cooking BTU-Main: 48,000
Cooking BTU-Side: 13,000

ACCESSORIES

Covers: #55524, 66444
Rotisseries: #101484, 297956

DURABILITY

Cooking surface: Cast-iron
Ignition: Electronic
Burner: Stainless steel

WARRANTIES Burner: 1 year | Parts: 1 year



Char-Broil

Two-Burner Propane Barbeque

#286515

2 Burners | **26,500** Total BTU | **18** Burger Count

PERFORMANCE

Cooking area: 265 sq. in.
Cooking BTU-Main: 26,500

ACCESSORIES

Covers: #187623, 55576

DURABILITY

Cooking surface: Porcelain-wire
Ignition: Push button
Burner: Stainless steel

WARRANTIES Burner: 1 year | Parts: 1 year

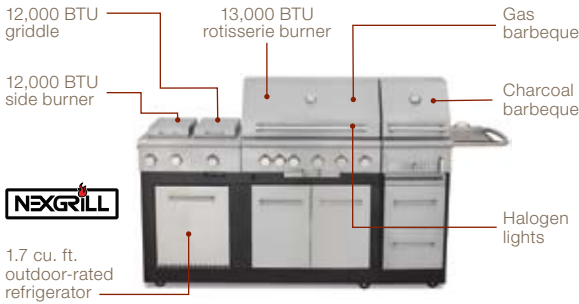

Five-Burner Propane & Charcoal Outdoor Kitchen

#296477

5 Burners | **89,000** Total BTU | **65** Burger Count

PERFORMANCE

Cooking area: 1080 sq. in.
 Cooking BTU-Main: 52,000
 Cooking BTU-Side: 12,000
 Cooking BTU-Rotisserie: 13,000
 Cooking BTU-Griddle: 12,000

DURABILITY

Cooking surface: Stainless steel & Porcelain cast-iron
 Ignition: Electronic
 Burner: Stainless steel

ACCESSORIES

Cover: Included
 Rotisseries: #101484, 297956 (gas side only)
 Natural Gas Conversion Kit: #107694

WARRANTIES Burner: 5 years | Parts: 1 year

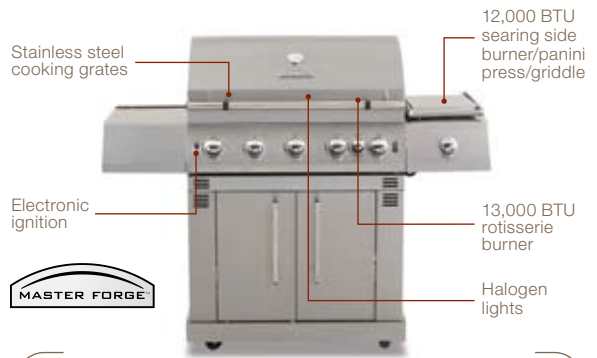

Five-Burner Propane Barbeque with Panini Press

#314075

5 Burners | **91,250** Total BTU | **45** Burger Count

PERFORMANCE

Cooking area: 787 sq. in.
 Cooking BTU-Main: 66,250
 Cooking BTU-Side: 12,000
 Cooking BTU-Rotisserie: 13,000

DURABILITY

Cooking surface: Porcelain cast-iron
 Ignition: Electronic
 Burner: Stainless steel

ACCESSORIES

Covers: #297983, 55524
 Rotisseries: #101484, 297956
 Natural Gas Conversion Kit: #50772

WARRANTIES Burner: 5 years | Parts: 1 year



Four-Burner Propane Barbeque

#134489

4 Burners | **60,000** Total BTU | **35** Burger Count

PERFORMANCE

Cooking area: 667 sq. in.
 Cooking BTU-Main: 48,000
 Cooking BTU-Side: 12,000

DURABILITY

Cooking surface: Porcelain-coated cast-iron
 Ignition: Electronic
 Burner: Stainless steel

ACCESSORIES

Covers: #297983, 140846, 55524
 Rotisseries: #101484, 297956

WARRANTIES Burner: 3 years | Parts: 1 year

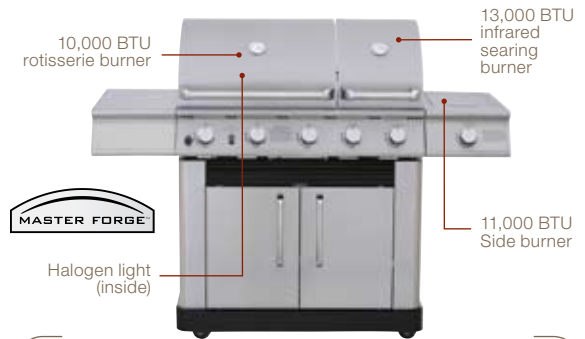

Four-Burner Split Lid Propane Barbeque

#67087

4 Burners | **73,750** Total BTU | **50** Burger Count

PERFORMANCE

Cooking area: 893 sq. in.
 Cooking BTU-Main: 52,750
 Cooking BTU-Side: 11,000
 Rotisserie BTU: 10,000

DURABILITY

Cooking surface: Porcelain cast-iron
 Ignition: Electronic
 Burner: Stainless steel

ACCESSORIES

Covers: #297940, 55257
 Rotisseries: #297956, 101484 (extender included with barbeque)
 Natural Gas Conversion Kit: #81805

WARRANTIES Burner: 5 years | Parts: 1 year



Four-Burner Propane Barbeque

#241317 / 241318

4 Burners | **66,500** Total BTU | **35** Burger Count

PERFORMANCE

Cooking area: 600 sq. in.
 Cooking BTU-Main: 53,000
 Cooking BTU-Side: 13,500

ACCESSORIES

Covers: #297936, 55257, 66444
 Rotisseries: #101484, 297956

PROPANE #241317

DURABILITY

Cooking surface: Stainless steel
 Ignition: Push-and-Turn
 Burner: Stainless steel

NATURAL GAS #241318

WARRANTIES Burner: 5 year limited | Parts: 1 year limited



Four-Burner Propane Barbeque

#296449

4 Burners | **58,000** Total BTU | **35** Burger Count

PERFORMANCE

Cooking area: 674 sq. in.
 Cooking BTU-Main: 48,000
 Cooking BTU-Side: 10,000

ACCESSORIES

Covers: Included
 Rotisseries: #101484, 297956

WARRANTIES

Burner: 5 years | Parts: 1 year

DURABILITY

Cooking surface: Porcelain cast-iron
 Ignition: Push-and-Turn
 Burner: Stainless steel



Four-Burner Propane Barbeque

#314073

4 Burners | **70,000** Total BTU | **40** Burger Count

PERFORMANCE

Cooking area: 738 sq. in.
 Cooking BTU-Main: 48,000
 Cooking BTU-Side: 12,000
 Cooking BTU-Rotisserie: 10,000

ACCESSORIES

Covers: #297983, 140846, 297940
 Rotisseries: #101484, 297956
 Natural Gas Conversion Kit: #50772

WARRANTIES Burner: 5 years | Parts: 1 year

DURABILITY

Cooking surface: Porcelain coated stamped steel
 Ignition: Electronic
 Burner: Stainless steel



Three-Burner Propane Barbeque

#196124

3 Burners | **54,000** Total BTU | **28** Burger Count

PERFORMANCE

Cooking area: 624 sq. in.
 Cooking BTU-Main: 42,000
 Cooking BTU-Side: 12,000

ACCESSORIES

Covers: #297938, 187621, 55524, 66444
 Rotisseries: #101484, 297956

WARRANTIES

Burner: 5 years | Parts: 1 year

DURABILITY

Cooking surface: Porcelain cast-iron
 Ignition: Electronic
 Burner: Stainless steel



charcoal, portable & specialty barbeques

We offer a wide selection of charcoal, electric, tabletop and portable barbeques. All from the brands you trust, and all at everyday low prices.



(Left)
Char-Griller
Super Pro
Charcoal
Barbeque/
Smoker
#44754



22.5 in. Performer Charcoal Barbeque #177887

24 Burger Count

PERFORMANCE

Cooking area: 363 sq. in.

ACCESSORIES

Covers: #297942

WARRANTIES

Cart: 2 years | Parts: 2 years

DURABILITY

Cooking surface:
Chrome-plated steel wire

Burner: Stainless Steel



Super Pro Charcoal Barbeque/Smoker #44754

40 Burger Count

PERFORMANCE

Cooking area: 850 sq. in.

ACCESSORIES

Covers: #99169

Side firebox: #11236

WARRANTIES

Cart: 1 year | Parts: 1 year

DURABILITY

Cooking surface: Cast-iron

Charcoal grate:
Adjustable/removable



Ceramic Grill with Side Shelves #184179

18 Burger Count

PERFORMANCE

Cooking area: 553 sq. in.

ACCESSORIES

Cover: Included

WARRANTIES

Cart: 5 year limited | Parts: 5 year limited

DURABILITY

Cooking surface:
Stainless steel rod

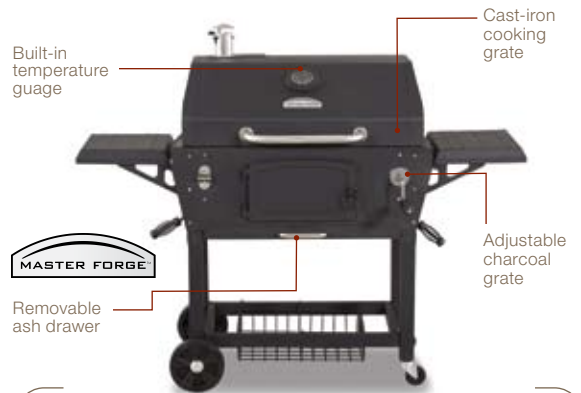

Heavy-Duty Charcoal Barbeque #177898

45 Burger Count

PERFORMANCE

Cooking area: 800 sq. in.

ACCESSORIES

Cover: 297938, 55524

WARRANTIES

Cart: 1 year | Parts: 1 year

DURABILITY

Cooking surface:
Cast-iron

Charcoal grate:
Adjustable height



Long-lasting porcelain-enameled bowl and lid

22.5 in. One-Touch Kettle Charcoal Barbeque

#27071

24 Burger Count

PERFORMANCE

Cooking area: 363 sq. in.

DURABILITY

Cooking surface:
Chrome-plated steel wire

ACCESSORIES

Covers: #94680

WARRANTIES

Cart: 2 years | Parts: 2 years

Aussie™



Folding side table

Folding legs for storage and portability

Walk-about Folding Charcoal Barbeque

#176140

25 Burger Count

PERFORMANCE

Cooking area: 332 sq. in.

DURABILITY

Cooking surface:
Chrome-plated steel

WARRANTIES

Parts: 90 day



Hinged lid

Removable ash catcher

22.5 in. Charcoal Kettle Barbeque

#316162

24 Burger Count

PERFORMANCE

Cooking area: 539 sq. in.

DURABILITY

Cooking surface:
Porcelain steel wire

ACCESSORIES

Cover: #187619, 140863

WARRANTIES

Parts: 3 years



Folding legs for storage and portability

Folding Charcoal Barbeque

#316158

20 Burger Count

PERFORMANCE

Cooking area: 376 sq. in.

DURABILITY

Cooking surface:
Chrome-plated steel wire

WARRANTIES

Parts: 1 year



Q 120 Portable Gas Barbeque		#297992
1 Burners	8,500 Total BTU	12 Burger Count
PERFORMANCE Cooking area: 189 sq. in. Cooking BTU: 8,500	DURABILITY Cooking surface: Porcelain cast-iron Ignition: Electronic Burners: Stainless steel	
ACCESSORIES Folding stand: #298000		
WARRANTIES Burner: 2 years Parts: 2 years		



Smokey Joe Portable Charcoal Barbeque		#297996
12 Burger Count		
PERFORMANCE Cooking area: 147 sq. in.	DURABILITY Cooking surface: Chrome-plated steel wire	
WARRANTIES Bowl & Lid: 10 years Parts: 1 year		



Portable Propane Barbeque		#184543
1 Burners	10,000 Total BTU	12 Burger Count
PERFORMANCE Cooking area: 343 sq. in.	DURABILITY Cooking surface: Porcelain steel	
WARRANTIES Parts: 2 years		



Portable Charcoal Barbeque		#297995
16 Burger Count		
PERFORMANCE Cooking area: 212 sq. in.	DURABILITY Cooking surface: Chrome-plated steel wire	



Patio Bistro Electric Barbeque		#186836
1 Burners	1,500 Watts	14 Burger Count
PERFORMANCE Cooking area: 320 sq. in. Primary Heat: 1,500 watts	DURABILITY Cooking surface: Porcelain coated steel	
ACCESSORIES Cover #187619		



Portable Charcoal Barbeque/Side Firebox		#11236
20 Burger Count		
PERFORMANCE Cooking area: 250 sq. in. Use as portable grill or side firebox for Char-Griller Super Pro #44754	DURABILITY Cooking surface: Steel wire	



BRINKMANN®

Charcoal Charcoal Smoker

#95542

50 lb. Meat Capacity

PERFORMANCE

Cooking area: 428 sq. in.

DURABILITY

Cooking surface:
Chrome-plated steel

ACCESSORIES

Covers: #187619



Dual Door Propane Smoker

#190449

1 Burners | **15,000** Total BTU | **12** Burger Count

PERFORMANCE

Cooking area: 784 sq. in.

DURABILITY

Cooking surface:
Chrome-plated steel

ACCESSORIES

Covers: #187619

WARRANTIES Burner: 1 year | Parts: 1 year



accessories

From rotisseries to smoking chips, barbeque covers to brushes, we offer accessories for every outdoor cook.



Weber Classic Apron

#297965

Weber Classic Mitt

#297966

Weber Classic 3-Piece Tool Set

#297920



5-Piece Stainless Steel Tool Set

#40049

- Comfort grip handle
- Includes spatula, tongs, basting brush, fork and barbeque brush



4-Piece Stainless Steel Tool Set

#102714

- Comfort grip handle
- Includes spatula, tongs, basting brush, fork



A



C



B



D

A Lined Vinyl Barbeque Cover

#55524 / #55576

- Fits cart style barbeques up to 68 in. wide
- #55524 fits 68 in.; #55576 fits 53 in.

B Sand Polyester Barbeque Cover

#66444

- Fits cart style barbeques up to 68 in.

C Heavy-Duty PVC Barbeque Cover

#55257

- 68 in. oversized heavy-duty barbeque cover

D Deluxe Two-Tone Barbeque Cover

#140846

- Fits to 68 in.

Additional Covers

- Commercial Series fits to 67 in. #297936
- Heavy-duty fits to 58 in. #297938
- Ultimate Series fits to 66 in. #297940
- Black Vinyl fits to 68 in. #187621
- Black PVC fits to 53 in. #187623
- Deluxe Cover fits to 58 in. #297938
- Premium Weber Spirit E-300 Series Cover #7047
- Premium Weber Genesis E & S Series Cover #180176
- Premium Weber Summit 400 Series Cover #297944
- Premium Weber Performer Cover #297942
- Char-griller Super Pro Cover #99169
- Char-griller Duo Cover #287133
- Smoker/Kettle Grill Cover #187619



"Brush Hawg" Barbeque Brush

#216842

Hawg Stainless Brush Replacements

#280598

Hawg Scrubbing Pad Replacements

#280599

Hawg Stainless Pad Replacements

#280600



Non-Stick Square Wok

#194524

- Non-stick surface with rolled handles
- Perfect for vegetables and seafood
- Square shape fits in barbeque corners
- 18-20 cup capacity



Rotisserie Kits

#101484 / 297956

- Universal mounting bracket and spit rod fits most gas barbeques
- ULc listed dual direction electric motor
- 40 in. rod
- Easy to set-up and install

Also Available:

- 51483 Weber Genesis Rotisserie
- 85787 Weber Summit Rotisserie



Deck / Patio Protector Pad

#117446

- Protects deck, patio, porch, or dock
- Slip resistant, textured surface, breathes not allowing moisture to accumulate
- 42 in. x 30 in.

Also Available:

#140235 Splatter Mat



20 lb. Propane Tank

#28271

- Overfill protection valve

Also Available:

- #28370 100 lb. Propane Tank
- #326313 Tank Holder
- #326314 Propane Tank Gauge



High-Power LED Barbeque Light

#246621

- 16 high intensity LED bulbs
- Two-in-one clamp with strong magnets can attach to any barbeque
- 22 in. flexible steel arm



Sizzle Q-Griddle

#166755

- Stainless steel
- 1 year warranty



Weber
Three-Burner
Genesis®
EP-310™
Black Propane
Barbeque
#222412

Credit

With low monthly payments and no annual fees, the Lowe's credit card offers a wide range of flexible credit services specially designed for your needs. You can also view and pay your bill free online. For more information visit Lowe's.ca



lowes.ca



Home Improvement Warehouse™

© 2010 by Lowe's. All rights reserved. Lowe's and the gable design are registered trademarks of LF, LLC.

